

RUBBLE MASONRY VENEER SUPPORT

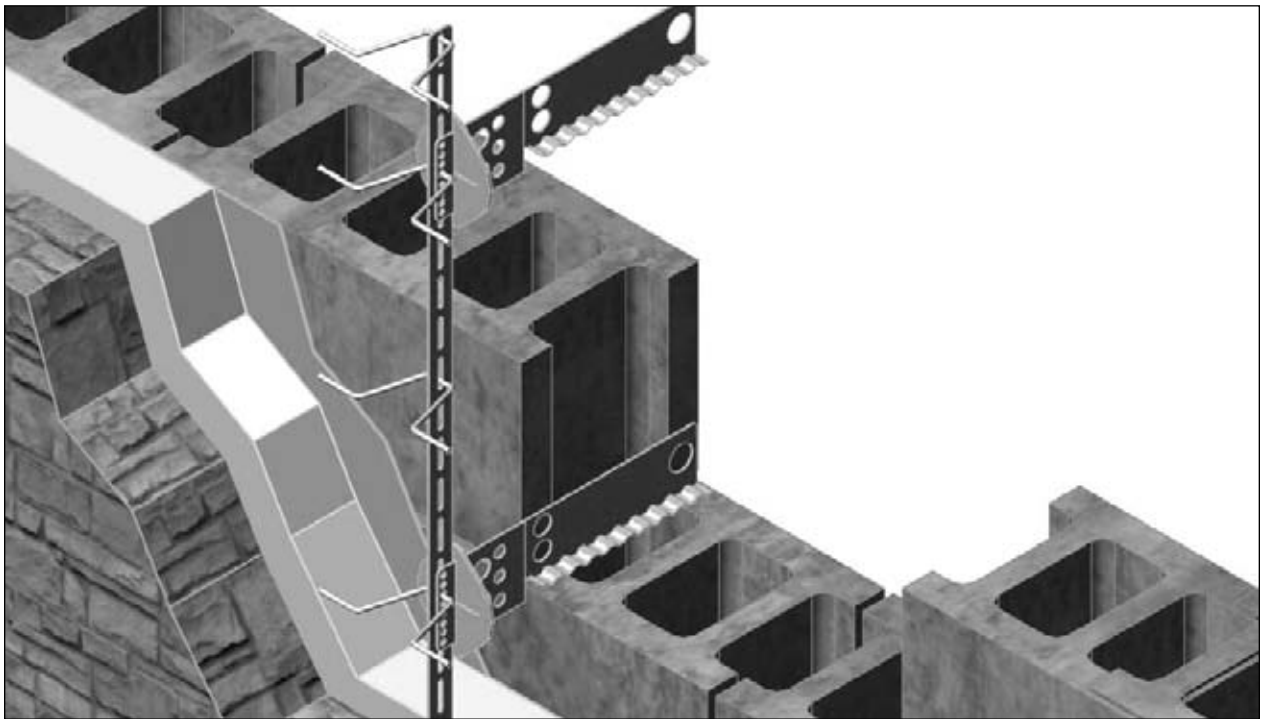

Not to Scale

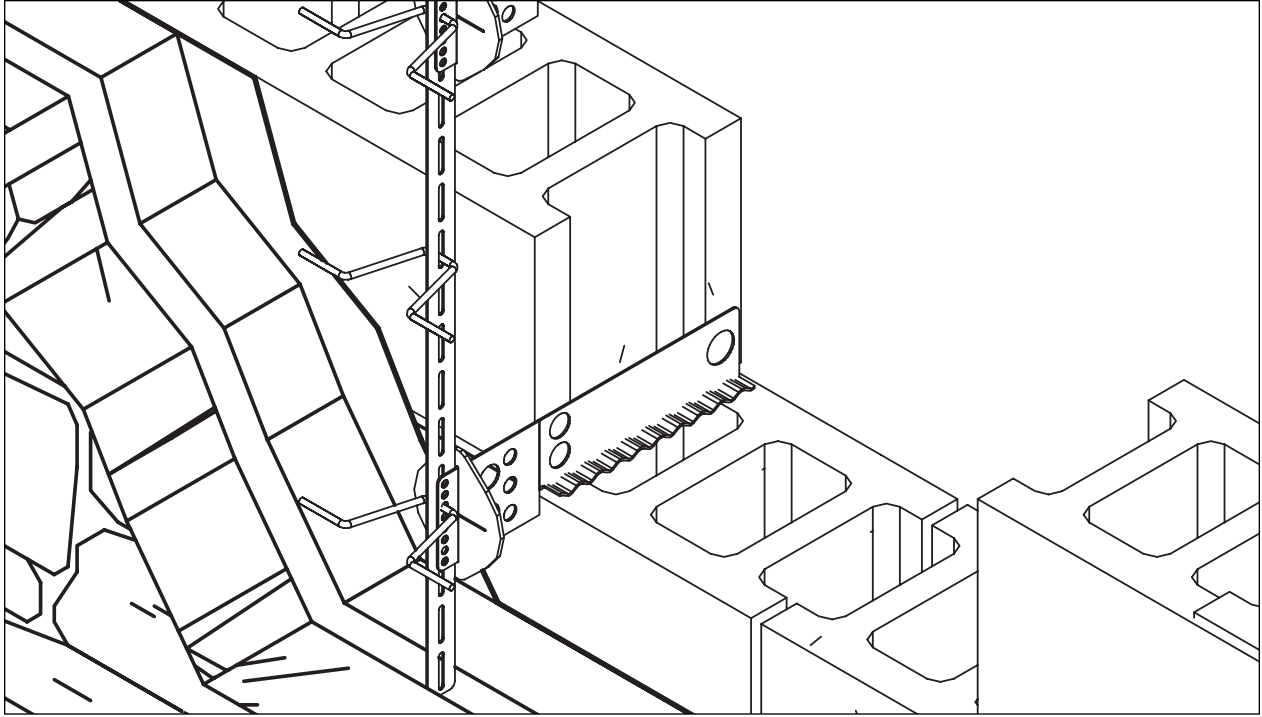
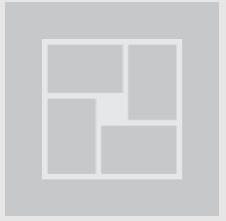
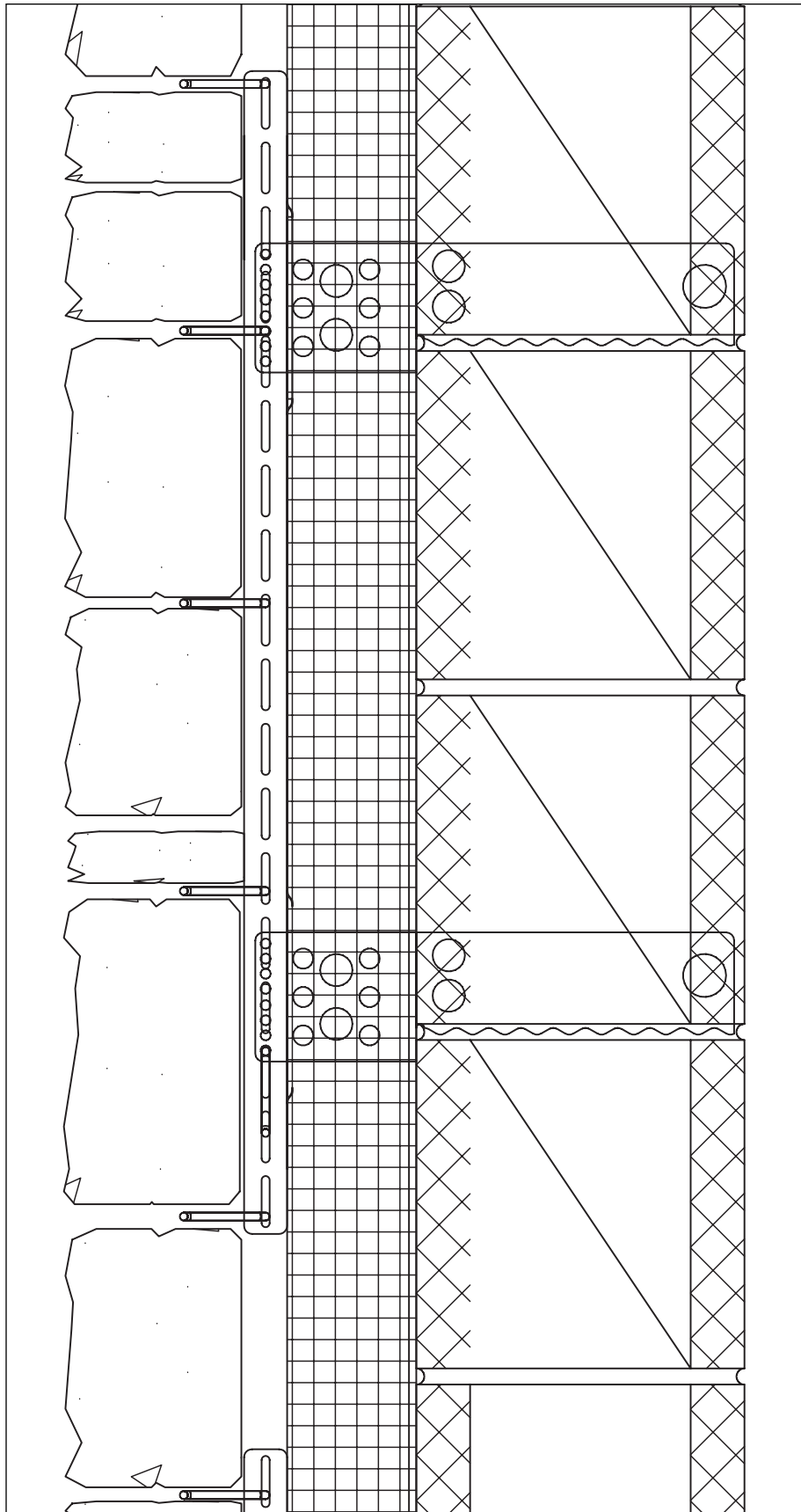

Scale 3" = 1'



MASONRY BACKUP WALL

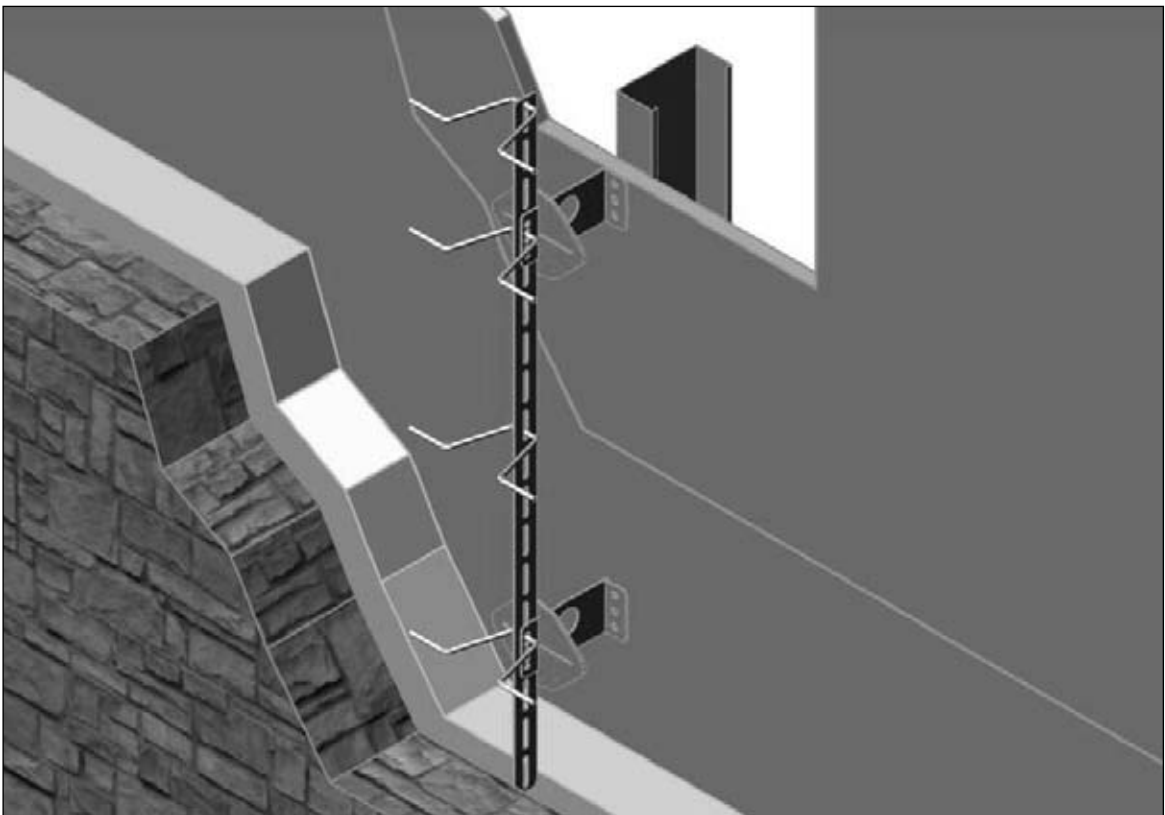
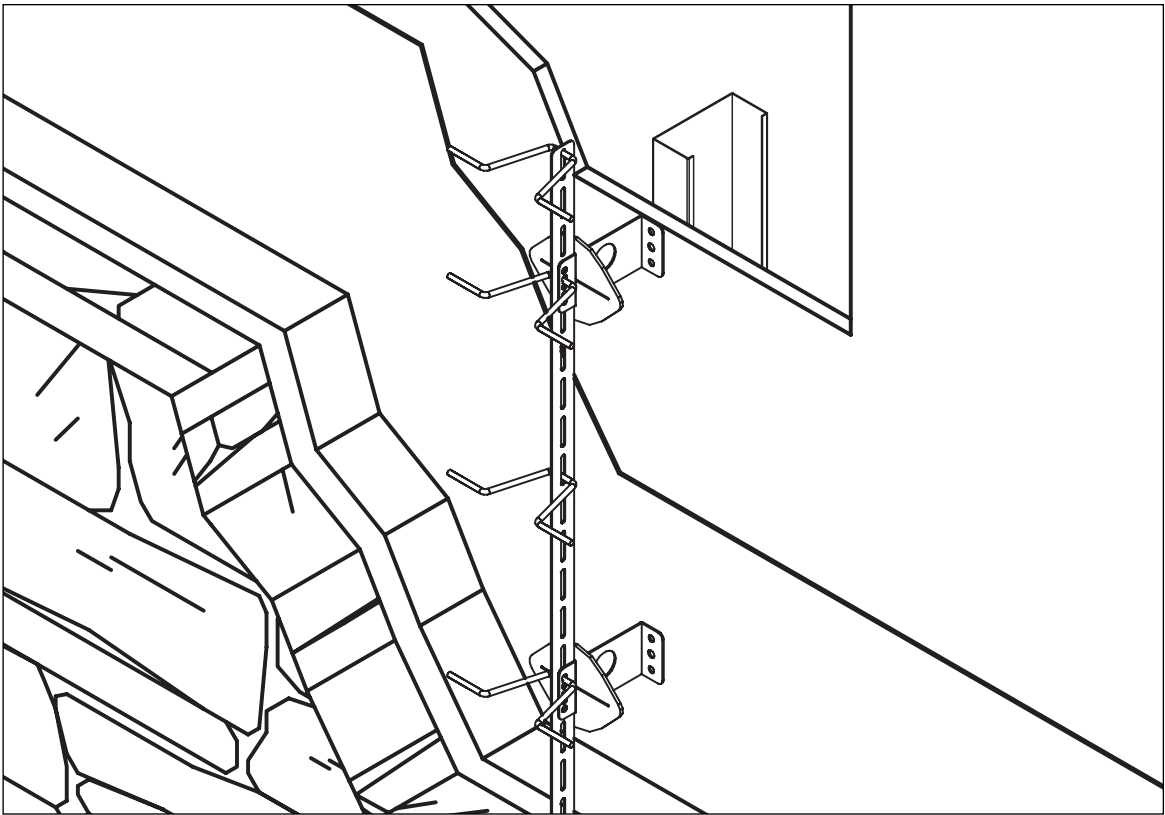

Not to Scale

METAL STUD BACKUP WALL



Fero Corporation
15305 - 117 Avenue, Edmonton, Alberta T5M 3X4
Phone: (780) 455-5098 Fax: (780) 452-5969
www.ferocorp.com info@ferocorp.com

Scale 3" = 1'

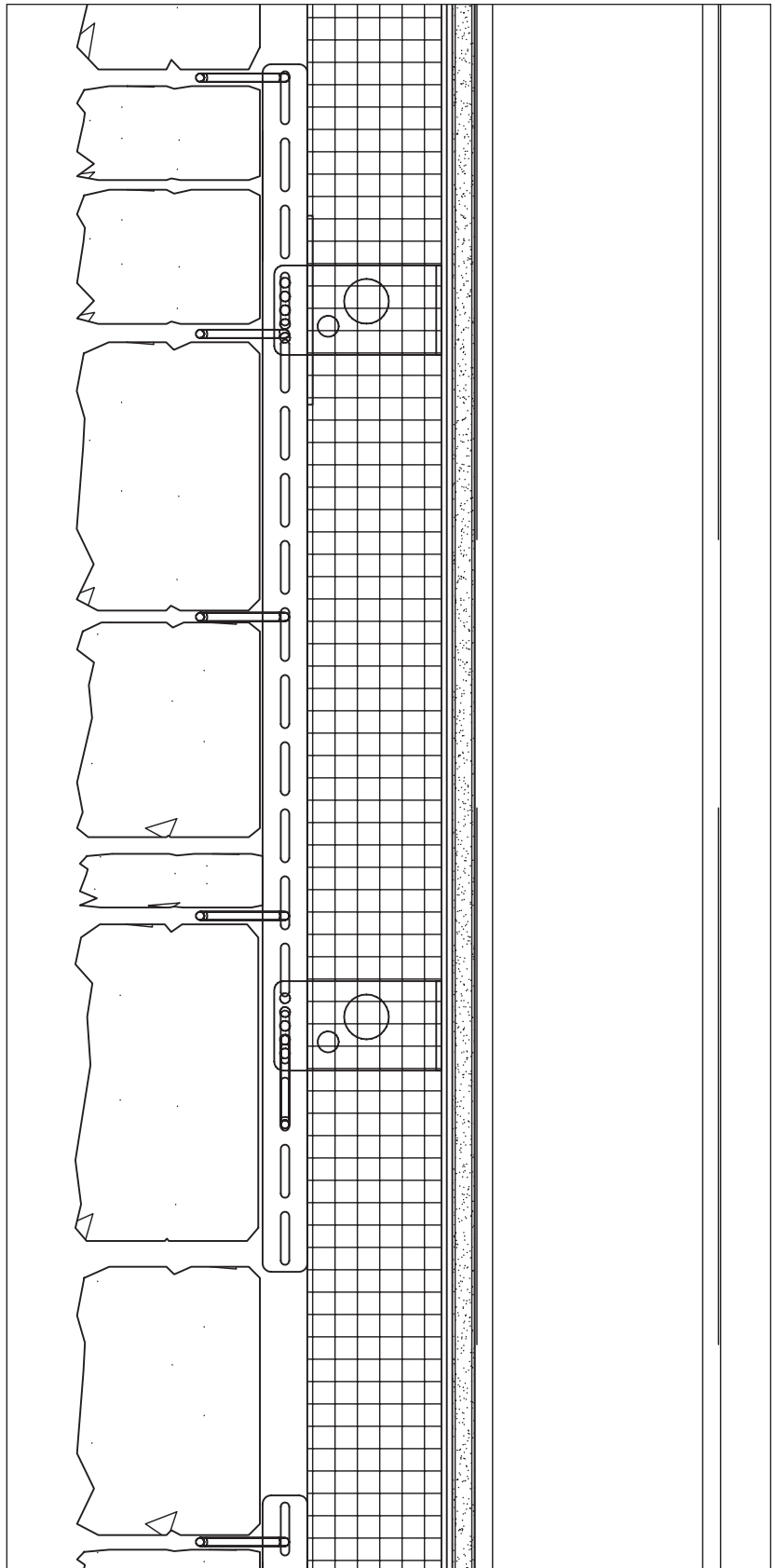

METAL STUD BACKUP WALL